

# SUGGESTIONS

## ELEVATE STORAGE

Create a solution that suits your needs. Start with the Elevate frame and build your storage up.

Here are a few suggested configurations. You could even play with colours and stack a combination of wood grain or solid colour storage units for a unique look.

It is not recommended to go higher than 4 levels of storage without securing it to a wall.



Config. 01



Config. 02



Config. 03



Config. 04



Config. 05



Config. 06



Config. 07

### GUIDE LINES

Always start with the Elevate frame and build your storage up.

The base of each storage unit is pre-drilled and fitted with plastic grommets. Use the screws that accompanies the storage to fasten the storage unit to the frame.

Inside each storage unit, on the underside of the top, are 1mm pilot holes so that once all the units are stacked they can be fixed in place with the screws supplied.



ELEVATE DESK LEG

Create side storage for an Evolution single desk. The Evolution leg frame, with one side short enough to rest on a elevate storage unit (570 high)

50 x 900 x 700 LHS 712 159 019  
50 x 900 x 700 RHS 712 159 020



ELEVATE CUSHION 600

Add the cushion(s) on top of the Elevate open box(es) to create a bench for seating.

600 x 450 x 47 712 159 014



ELEVATE FRAME 1200

Start with the Elevate frame and build your storage up. Available in Matte black, Light grey, Aluminium grey or White powder coating.

1200 x 450 x 200 712 159 011



ELEVATE OPEN BOX 1200

This open storage box can fit books or magazines and can serve as a bench or be stacked in between other elevate storage units.

1200 x 450 x 180 712 159 005



ELEVATE S/D CABINET 1200

This sliding door cabinet is lockable and can fit lever arch files.

1200 x 450 x 370 712 159 008

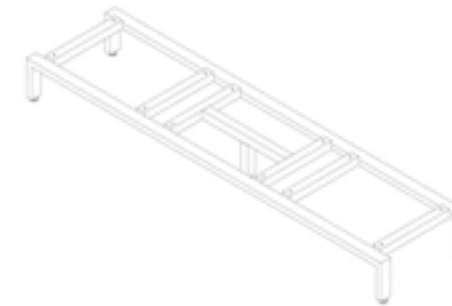

ELEVATE FRAME 1800

Start with the Elevate frame and build your storage up. Available in Matte black, Light grey, Aluminium grey or White powder coating.

1800 x 450 x 200 712 159 010

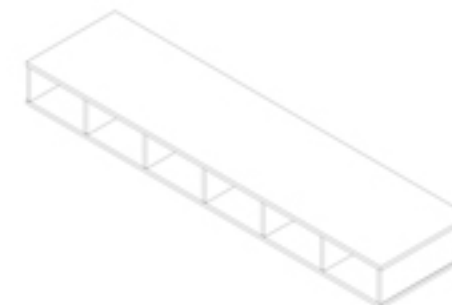

ELEVATE OPEN BOX 1800

This open storage box can fit books or magazines and can serve as a bench or be stacked in between other elevate storage units.

1800 x 450 x 180 712 159 012



ELEVATE DRAWERS 600

These drawers have central locking and are spacious with a storm gray box.

600 x 450 x 370 712 159 004



ELEVATE OPEN BOX WITH SHELF 600

This open storage fits A4 books and Lever arch files. Ideal to be used next to the Elevate Drawers as side storage at an Evolution desk.

600 x 450 x 370 712 159 002

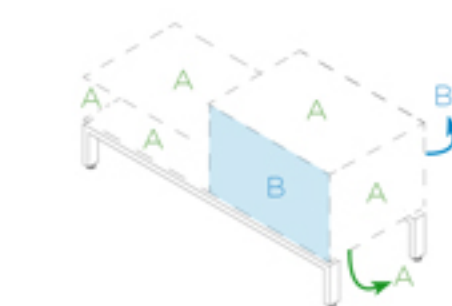

TWO-TONE RULES

A - Sides  
A - Top & Bottom  
B - Back  
B - Drawer fronts/Doors



ELEVATE STORAGE WITH HINGE DOORS 1200

This open storage box can fit both books or Lever arch files. The centre shelf is height adjustable to suit your needs.

1200 x 450 x 370 712 159 007

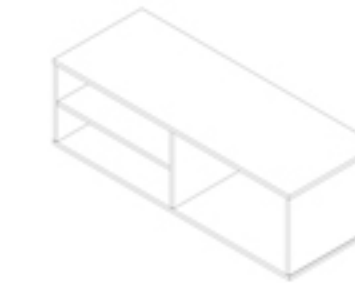

ELEVATE OPEN BOX WITH SHELF 1200

This open storage box can fit both A4 books or Lever arch files. The shelf is height adjustable to suit your needs.

1200 x 450 x 370 712 159 006

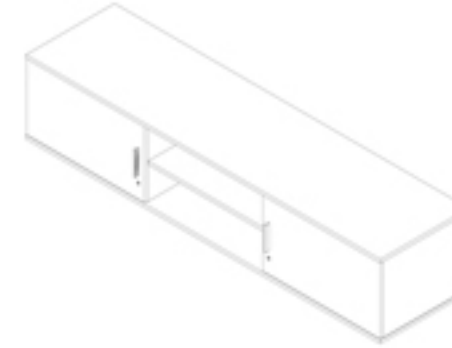

ELEVATE STORAGE WITH HINGE DOORS 1800

This open storage box can fit both books or Lever arch files. The centre shelf is height adjustable to suit your needs.

1800 x 450 x 370 712 159 009

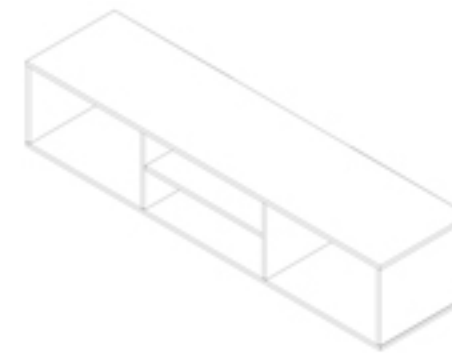

ELEVATE OPEN BOX WITH SHELF 1800

This open storage box can fit both A4 books or Lever arch files. The shelf is height adjustable to suit your needs.

1800 x 450 x 370 712 159 013

### NOT ELEVATE STORAGE



EVOLUTION LOCKER 722 (FREE-STANDING, NO FRAME)

6 compartments  
22mm top and bottom  
Fits Lever Arch Files  
4 Digit Combination Lock  
Adjustable Ferruls

1510 x 450 x 722 712161001



EVOLUTION LOCKER 1082 (FREE-STANDING, NO FRAME)

6 compartments  
22mm top and bottom  
Fits Lever Arch Files  
4 Digit Combination Lock  
Adjustable Ferruls

1510 x 450 x 1082 712161002





# ELEVATE

A RANGE OF MODULAR STORAGE SET  
ON A STEEL FRAME STRUCTURE



## POWDER COATING COLOURS

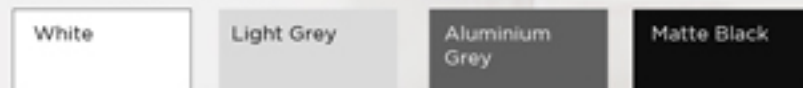

## MELAMINE COLOURS

